

eKOMPACT

V E R S A T I L E T E C H N O L O G Y



eKOMPACT

Promotal conducted the largest ever survey of medical examination furniture with 200 doctors from 6 European and Middle East countries. This allows us to develop adapted products with a high added value.

eKompact is currently the most suitable height-adjustable examination table for healthcare professionals and their environment. In addition to its sitting position, its storage and integrated retractable stirrups allow you to perform a complete examination on a 1m³ table. It becomes a real assistant for the patient and the practitioner by adapting to their morphology and preferences thanks to the ability to record favourite positions and its autonomous movements.

WARRANTY
2 YEARS

LOAD CAPACITY
UP TO 205 KG

INTEGRATED LEG
REST EXTENSION
(AT THE SAME LEVEL
AS THE SEAT)

INTEGRATED
RETRACTABLE
STIRRUPS

ADJUSTABLE HEIGHT
FROM 48 TO 99.5 CM
WIDTH: 72 CM

THE TABLE IS
EQUIPPED WITH:

- 1 "PASS THROUGH" SIDE DRAWER (52X37X9)
- 1 FRONT DRAWER (50X17X7)

MODELS

40235-01	EKOMPACT STANDARD MODEL
40235-20	EKOMPACT ONE TOUCH MODEL
40235-25	EKOMPACT PREMIUM MODEL (+ ABS SIDE PANEL + WIRELESS PEDAL)
235150-70	SEAMLESS COMFORT UPHOLSTERY*

* Width 72cm, compatible with all 3 models, to be ordered separately, delivered unassembled.



EQUAL TREATMENT

MAKE LIFE EASIER FOR YOUR PATIENTS WITH REDUCED MOBILITY WITH:

- › A seated patient reception position at 48 cm
- › Gentle and safe electrical movements
- › Switching from the exam sitting position to lying down effortlessly thanks to the integrated legrest extension

EXAMINE ALL YOUR PATIENTS WITH THE SAME EASE:

- › Accommodates up to 205 Kg
- › Comfort upholstery - width 72 cm

SECURE YOUR EXAMS:

- › Safety sensors
- › Safety battery



EFFICIENCY

HAVE EVERYTHING YOU NEED IN 1M³:

- › A gynaecological position with retractable and adjustable stirrups
- › An ABS gynaecological tray (stainless steel option)
- › 2 storage drawers (1 Pass Through Side Drawer & 1 Front Drawer)
- › A large capacity roll holder integrated into the backrest (max length 50cm - diameter 20cm)
- › Seat rails (option)

MAKE YOUR EXAMS MORE FLUID THANKS TO:

- › Autonomous movements, the push of a button is enough to put the seat into position (depending on model)
- › The intuitive control and its pre-set patient reception position
- › Wireless pedal (option)

MAKE THE CLEANING OF YOUR TABLE EASY:

- › Seamless upholstery
- › Removable ABS tray
- › Electrically activatable castors by maintained contact (easy movement of the table - only for cleaning)



ERGONOMICS

CHANGE POSITIONS EFFORTLESSLY:

- › All-electric couch: Height, backrest
- › Registration of 3 completely configurable positions

WHATEVER YOUR SPECIALITIES

- › Gynaecologist, general practitioner, paediatrician

eKOMPACT

- OPTIONS
- ACCESSORIES

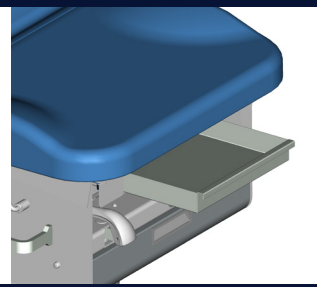
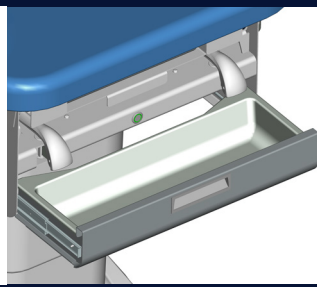
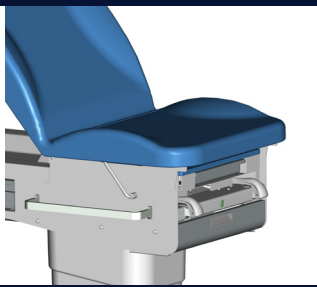
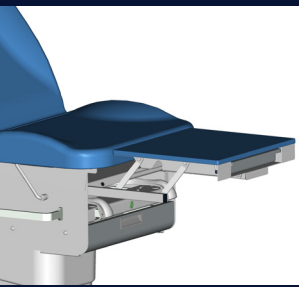

REF. 272-01
ADJUSTABLE FLUSH
LEG REST

REF. 278-01
PAIR OF RAILS
25X10MM

REF. 40996-01
WARMING DRAWER

REF. 4051-20
WIRELESS PEDAL

REF. 40966-01
STAINLESS STEEL TRAY
(REPLACING THE STD TRAY)

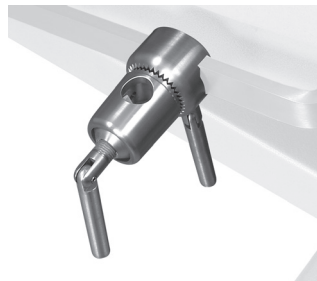
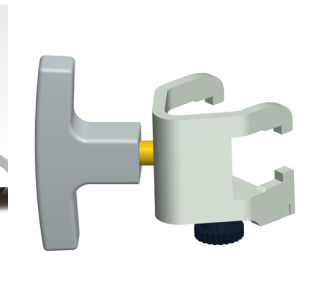

REF. 12851-01
PAIR OF STRAPS
FOR GOEPEL LEG
SUPPORTS

REF. 40400-1 EU/UK/US
REF. 40400-2 DK/IT/AUS/CH
INTEGRATED MAINS SOCKET
AND EQUIPOTENTIAL BONDING

REF. 878-12
SLIDING VICE FOR
RAIL 25X10 mm,
Ø 16/18 mm

REF. 879-10
ROTARY VICE FOR
RAIL 25x10 mm

REF. 236-01
ARM SUPPORT
(+ 878-12)

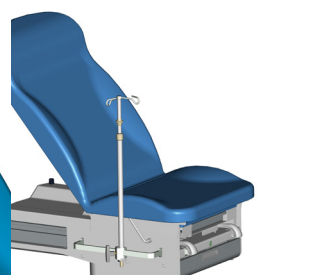
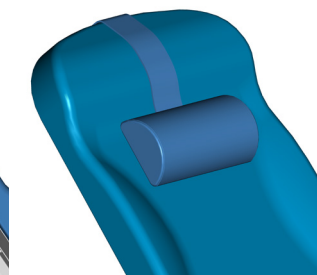
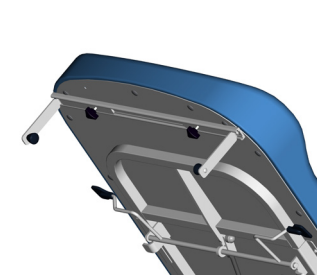
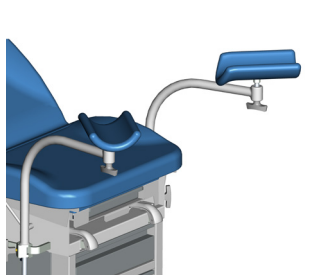

REF. 2537
ARM SUPPORT COVER

REF. 245-01
PAIR OF GOEPELS
(+ 2x 878-12)

REF. 2056-02
ADJUSTABLE ROLL
HOLDER
(350-800 mm)

REF. 11679-01
HEADREST

REF. 2985-01
SELF-TIGHTENING DRIP
STAND W/ 2 HOOKS
(+ 878-12)

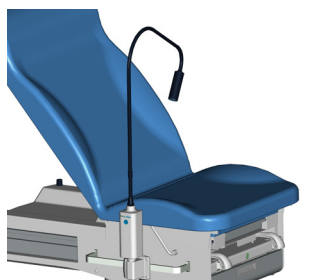
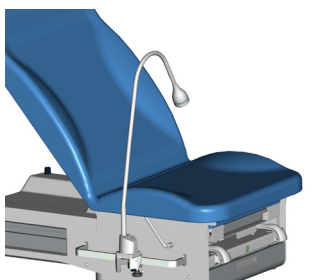
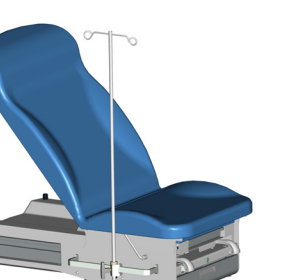

REF. 985-01
DRIP STAND
W/ 2 HOOKS
(+ 878-12)

REF. 295-01
LAMP SUPPORT LID
FOR RAIL* 25X10 MM

REF. 295-10
WELCH-ALLYN
LAMP HOLDER

REF. 40RVS100L
RVS100
LEFT BRACKET

REF. 40RVS100R
RVS100
RIGHT BRACKET

MODEL
40235-01 / 40235-20 / 40235-25

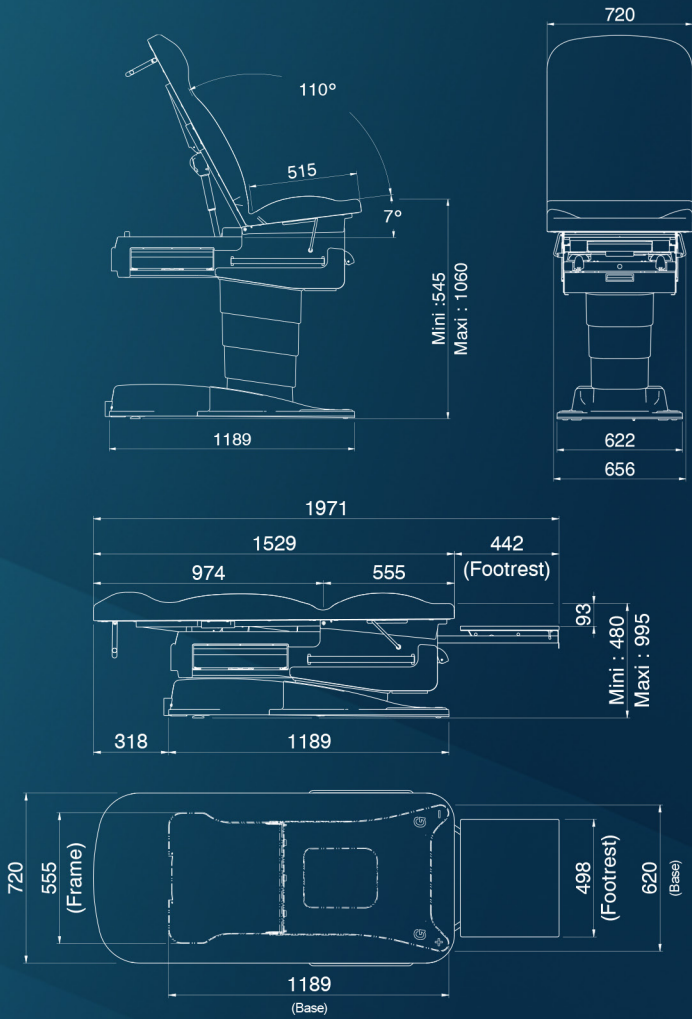

MODEL
40235-01 / 40235-20 / 40235-25 + Option 272-01

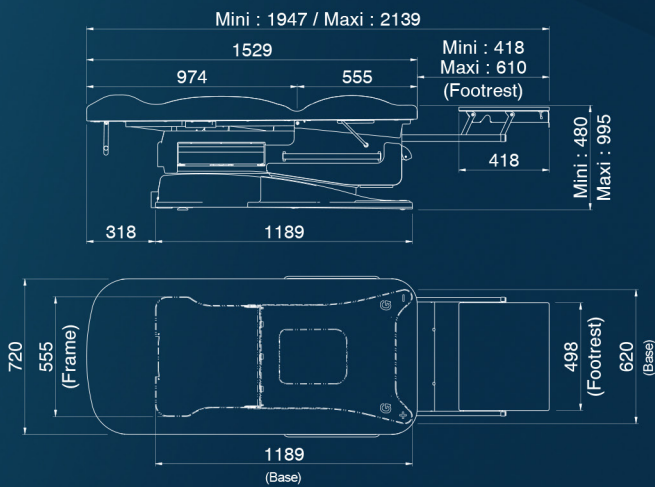

NET WEIGHT
COUCH : 187 kg
UPHOLSTERY : 12 kg

GROSS WEIGHT
COUCH : 220 kg
UPHOLSTERY : 16 kg

PACKAGE VOLUME
COUCH : 0,70 m³
UPHOLSTERY : 0,16 m³

UPHOLSTERY COLORS

- 32 - BLUE
 - 93 - COTTAGE
 - 35 - RED
 - 34 - YELLOW
 - 91 - WHITE
 - 92 - MARINE
 - 56 - DARKNESS
 - 57 - ANTISTATIC
 - 64 - GRAPE
 - 67 - LAGOON
 - 66 - SWEET
 - 63 - CEDRAT
 - 80 - SKY
 - 81 - SEA GREEN
 - 65 - LILAC
 - 96 - TIN
 - 82 - MOUSE GREY
 - 83 - NATURAL
 - 84 - CHOCOLATE
- CLASSIC**
- VITAMIN**
- COSY**

